ARCHIMODULE

LIMITLESS FREEDOM. AESTHETIC PERFECTION.





THE SYSTEM

Discover new worlds for your bathroom **4**

SHOWER AND BATH – A SENSORY DELIGHT FOR HIGH DEMANDS 6

Four out of countless possibilities

Elegant **6**

Compact **8**

Luxurious **10**

Individual **12**

WASHBASIN UNIT – PURE CLARITY MADE TO MEASURE 14

Two solutions that leave nothing to be desired

Comfortable **14**

Classic **16**

INSTALLATION

Perfection down to the last detail **18**

SHOWER AND BATH – INSTALLATION DETAILS 20

Four out of countless possibilities

Elegant **20**

Compact **22**

Luxurious **24**

Individual **26**

WASHBASIN UNIT – INSTALLATION DETAILS 28

Two solutions that leave nothing to be desired

Comfortable **28**

Classic **29**

MODULE OVERVIEW

34 Modules – endless possibilities **30**

OVERVIEW TABLE

Overview of Archimodule **38**

With our online configurator, you can assemble your personal design.
Just go to: www.archimodule.idealstandard.com

THE SYSTEM

Accept no compromises.

Design your bathroom exactly as you wish – without ifs or buts. With the modular fittings system Archimodule, you can choose individual solutions which are tailor-made to your requirements. The innovative fittings technology from Archimodule ensures the perfect look every time. Even unevenly plastered walls and fancy tile sizes are no problem.

The next generation of modular fittings.

Perfect design: lines up precisely with the tile pattern

Archimodule's harmoniously designed components adapt perfectly to the tiled section. This way the solution you choose matches the design in your mind's eye exactly. This is made possible by a mounting rail under the rendering which allows the modules to be adjusted individually.

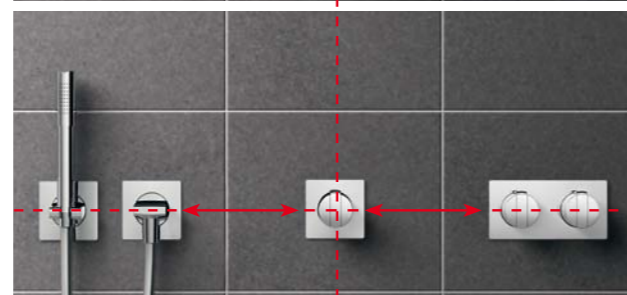
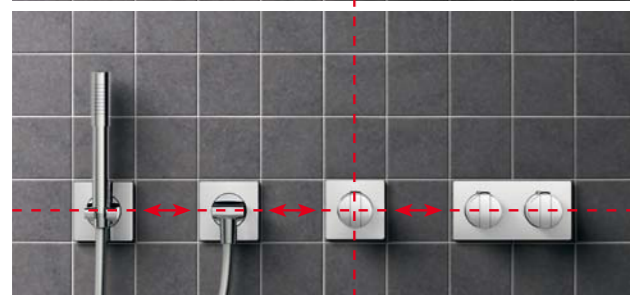
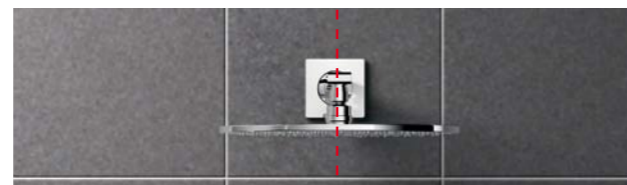
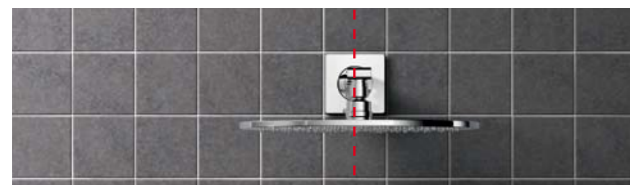

Get it just right: perfect angular alignment

Perfect appearance on the wall: all the visible components of the universal modules can be lined up accurately and precisely.



Solved with precision: compensation for inclination and wall separation

The telescopic function based on the universal modules ensures the fittings' perfect appearance from any point of view. It guarantees that the component is seated flat against the wall and projects uniformly out from it.

Limitless flexibility: Modular system

Archimodule's pioneering modular concept ensures absolute design freedom. The components of the fittings system can be combined just as you wish. You can choose freely among them and place them how you like. There are no restrictions on the way the modules can be arranged; there are practically no limits to design.

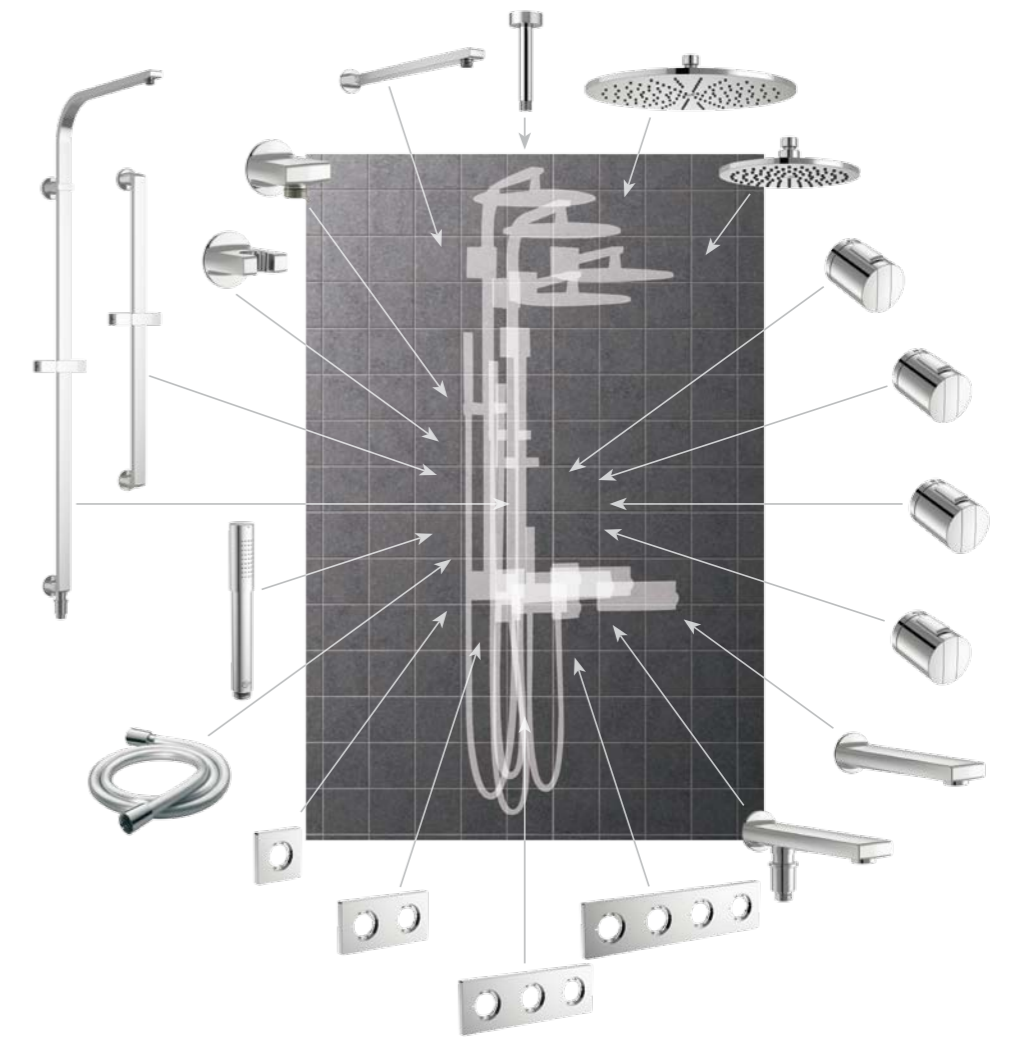

Comfort, safety and caring for the environment: Thermostat technology

Ideal Standard's tried and tested thermostat technology takes care of the environment due to reduced water and energy consumption. Furthermore, you enjoy maximum safety through effective protection against scalding as well as a high degree of comfort by easy regulation of the temperature and constant water temperature.

With our online configurator, you can assemble your personal design. Just go to: www.archimodule.idealstandard.com

ELEGANT

As stylish as it is comfortable: a wall-mounted rain shower as well as a hand shower with wall bracket ensure showering is a pleasure. The thermostat allows temperature control. Each shower head has its own volume control, which makes it possible to use them both separately or simultaneously.

Detailed information on the products can be found on pages 20/21.

The elegant bath tub concept allows the bath to be filled by means of the overflow fittings and thus offers a reduced design which dispenses with a separate outflow. A thermostat regulates the temperature. Thanks to the separate volume control of the bath inlet and the shower head, they can be used both separately or at the same time.



COMPACT

A wall-mounted rain shower as well as a shower rail with height-adjustable, pivoting hand shower offer all-round comfort. The thermostat allows temperature control. Each shower head has its own volume control, which makes it possible to use them both separately or simultaneously.

Detailed information on the products can be found on pages 22/23.

The compact bath tub solution offers a bath inlet with integrated, automatic changeover to the hand shower. The thermostat takes care of perfect temperature control. The result is an elegant and compact solution.

LUXURIOUS

A complete shower system with rain and hand shower on the water conducting shower rail provides a touch of luxury. The thermostat allows temperature control. Each shower head has its own volume control, which makes it possible to use them both separately or simultaneously.

Detailed information on the products can be found on pages 24/25.

The luxurious bath tub solution offers a bath inlet and a separate hand shower. A thermostat regulates the temperature. The volume control of the bath inlet and the shower head are separate, so they can be used both separately or at the same time.

INDIVIDUAL

A sensory delight for high demands.

With Archimodule, the bathroom becomes a space in tune with your personal style. Create your own individual oasis of wellness in your home and discover what rest, harmony and relaxation for all senses really mean.

- Total flexibility
- Flawless aesthetics
- Timelessly elegant design

INDIVIDUAL

The shower concept with rain shower and integrated, automatic changeover to the hand shower on the water-conducting shower rail demonstrates active individuality in the bathroom at its best. A thermostat takes care of optimum temperature control. This concept also permits the vertical arrangement of the temperature and volume controls.

Detailed information on the products can be found on pages 26/27.

The individual bath tub concept consists of a bath inlet with integrated, automatic changeover to the hand shower. Temperature control is by means of a precise thermostat.

Combinations to fulfill every wish

Choose a rain shower with wall or ceiling connection. Consider the possibility of a water-conducting shower rail. Decide between a wall spout or filling the bath through the overflow. You have no separate shower? No problem! Simply combine the solution of a shower with a bath tub. With Archimodule, you have every choice in the world.

With our online configurator, you can assemble your personal design. Just go to: www.archimodule.idealstandard.com



COMFORTABLE

The washbasin unit concept with thermostat and volume control offers all-round comfort. This way you enjoy all the advantages of your washbasin unit – from even temperature control by way of scald protection safety right up to carefully thought-through design.

Detailed information on the products can be found on page 28.



CLASSIC

Pure clarity made to measure.

Celebrate the union of design and function. With Archimodule the washbasin unit blends perfectly into your personal bathroom design— and becomes the visual and functional highlight.

- Individual solutions
- Perfect alignment
- Forward-looking technology

CLASSIC

Perfectly classic – the washbasin unit concept with separate hot and cold water control. Thus tried and trusted ideas are adapted to designs for the future.

Detailed information on the products can be found on page 29.

Be it the classic two-tap concept or the convenient thermostatic model: Archimodule fittings round off the design concept of your bathroom to perfection.

With our online configurator, you can assemble your personal design. Just go to:
www.archimodule.idealstandard.com

INSTALLATION

Perfection down to the last detail.

Time-saving, simple and precise installation – as well as total flexibility.

Thanks to state-of-the-art fittings technology, Archimodule offers the best quality from the very start. Create perfect design with ease.

Easy installation with Archimodule



The mounting rail makes it easy to arrange the modules quickly and accurately. It allows convenient pre-assembly of the components, which can then be fixed in the wall as one unit.

There are only two different flush-mounted components which are employed for all possible combinations of fittings.

DICHT-FIX: Guaranteed waterproof

Triple protection of concealed fittings against water:

- Seals on escutcheons against water splashes on the exterior
- Sealing felt provides reliable protection against water penetrating from outside
- Inserts where the pipe penetrates the wall prevent water seeping into the masonry



Innovative fixing design FAST-FIX

- Protruding connectors make it easy to apply the footprints.
- Optimum support surface for spirit level (horizontal and vertical)

Up to five installation variations

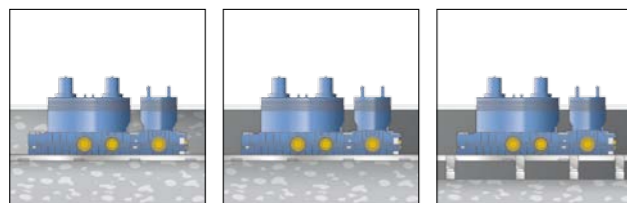

- Installation in the wall
- Installation on the wall
- Installation on support proud of the wall

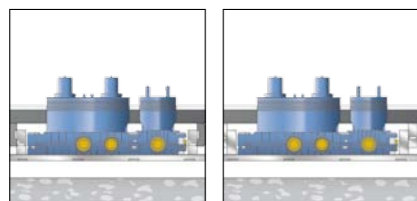

- On-wall installation: assembly using bracket system
- Installation on prefabricated bathroom units or bathroom pods

Depending on the installation position, one or more additional installation kits may be necessary

Low installation depth

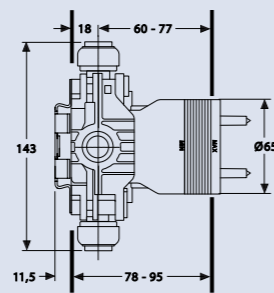

With a mere 78 to 95 mm, Archimodule offers one of the shallowest installation depths on the market.

Quick connection with Simplex push-on fittings

Simplex push-on fittings make it an easy job to connect up flush-mounted modules, simply and quickly. The push-on fittings you need are included with the modules, as is a special spanner to loosen them.

Flow rates

SHOWER – Elegant, Luxurious, Compact, Individual

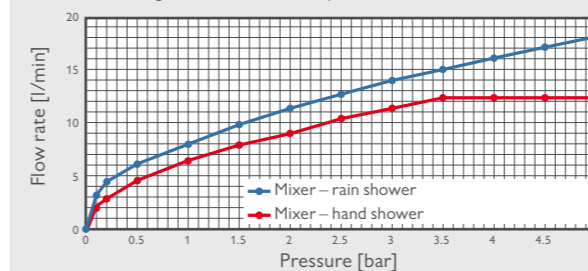

BATH – Elegant, Luxurious, Compact, Individual

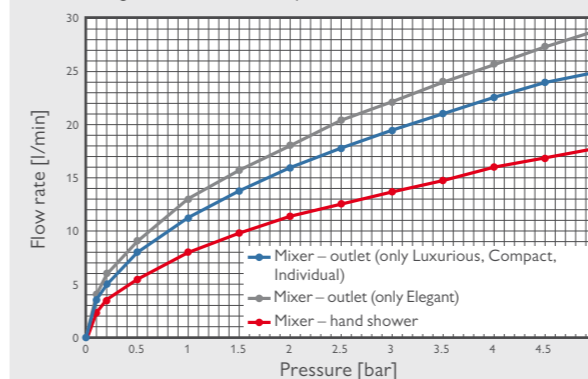

Perfect appearance with telescopic function

The telescopic function permits different installation depths of up to 17 mm to be levelled up without difficulty.

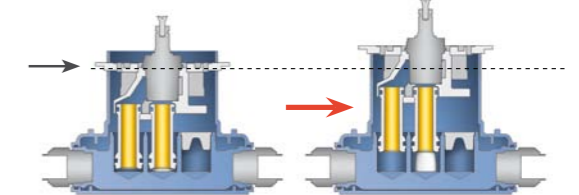

The solution provider

Even if things don't go right at the first go – we have the right solution on hand.

Problem: Installation too deep (despite telescopic function)

Solution: Extensions for surface-mounted elements

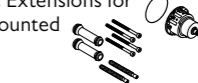

Problem: Hot and cold water connections reversed

Solution: minimum modification of existing components (possible even after installation)

Problem: installation too close to surface (despite telescopic function)

Solution: spacer

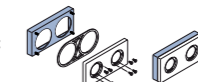

Problem: cut-outs in tiles or wall too large

Solution: larger escutcheons

With our online configurator, you can assemble your personal design. Just go to: www.archimodule.idealstandard.com

INSTALLATION

SHOWERS Elegant



MODULE LIST

- 1 × A1500NU
built-in kit 1 THERMOSTAT
- 4 × A1501NU
built-in kit 1 UNIVERSAL
- 1 × A1503NU
mounting rail 60 cm
- 1 × A1504AA
1 hole escutcheon 83 × 83 cm
- 1 × A1505AA
2-hole escutcheon 83 × 166 cm
- 1 × A1506AA
3 hole escutcheon 83 × 249 cm
- 1 × A1508AA
volume knob, hand shower
- 1 × A1509AA
volume knob, shower head
- 1 × A1512AA
temperature knob
- 1 × A3306AA
shower hose Idealflex 1,25 m
- 1 × A1519AA
stick hand shower
- 1 × A1520AA
wall bracket for hand shower
- 1 × A1521AA
wall elbow, flush-mounted
- 1 × B9443AA
rain shower Idealrain 300 mm
- 1 × A1524AA
wall connection 370 mm

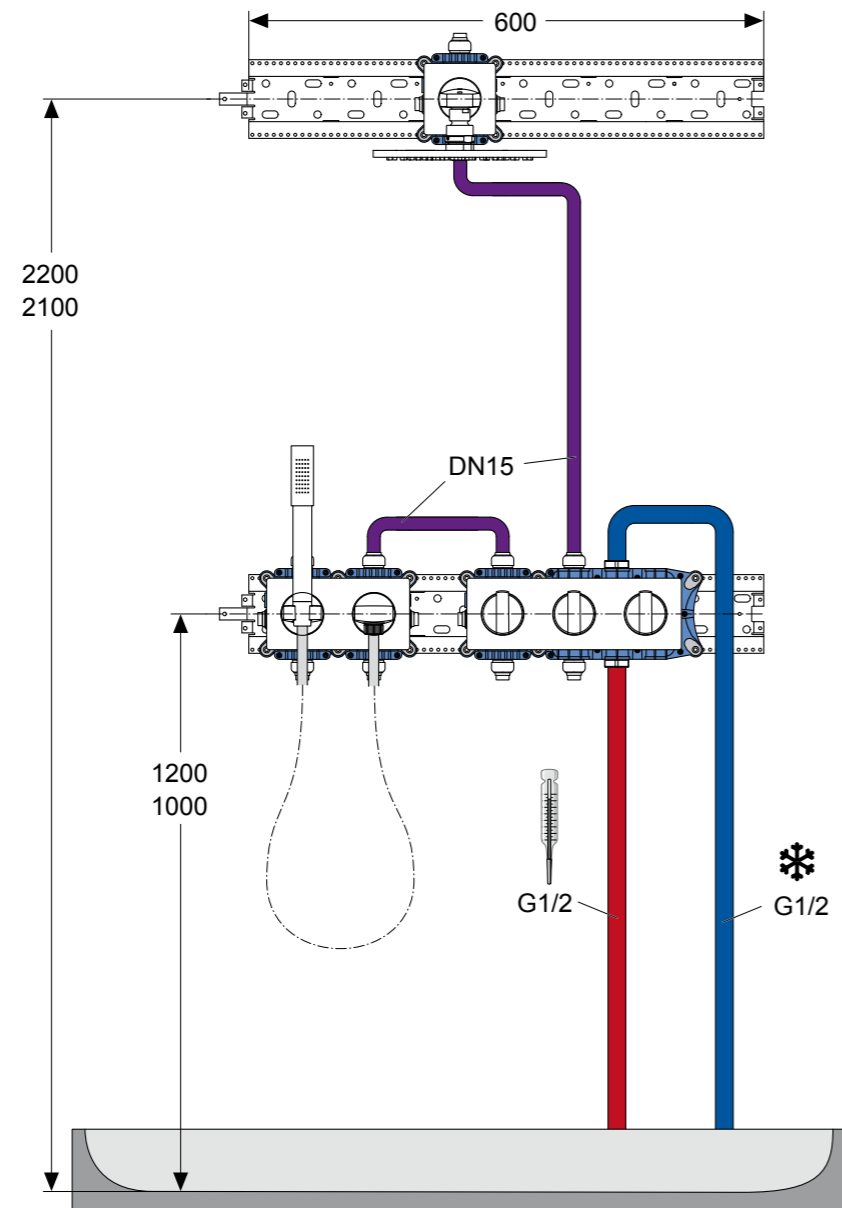

BATHS Elegant



MODULE LIST

- 1 × A1500NU
built-in kit 1 THERMOSTAT
- 3 × A1501NU
built-in kit 1 UNIVERSAL
- 1 × A1505AA
2-hole escutcheon 83 × 166 cm
- 1 × A1506AA
3-hole escutcheon 83 × 249 cm
- 1 × A1508AA
volume knob, hand shower
- 1 × A1511AA
volume knob, bath inlet
- 1 × A1512AA
temperature knob
- 1 × A3306AA
shower hose Idealflex 1.25 m
- 1 × A1519AA
stick hand shower
- 1 × A1520AA
wall bracket for hand shower
- 1 × A1521AA
wall elbow, flush-mounted

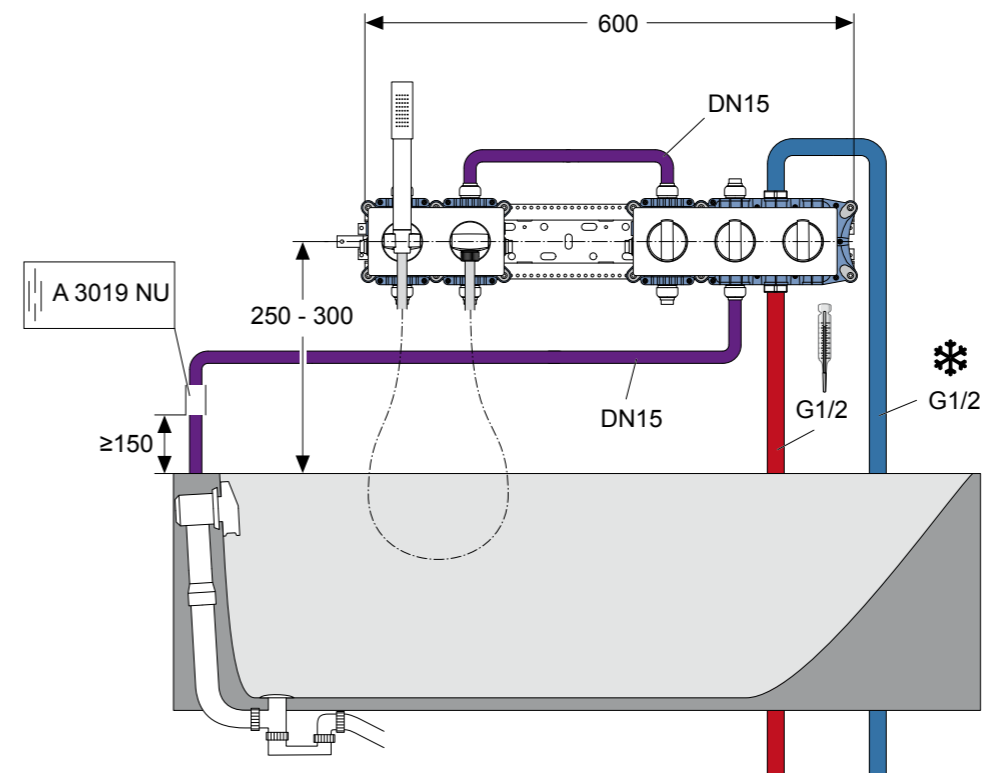

Flexible assembly

The installations shown are intended as examples only. The modules can also be assembled in different configurations – just as individual conditions demand.

INSTALLATION

SHOWERS Compact



MODULE LIST

- 1 × A1500NU
built-in kit 1 THERMOSTAT
- 3 × A1501NU
built-in kit 1 UNIVERSAL
- 1 × A1503NU
mounting rail 60 cm
- 2 × A1504AA
1-hole escutcheon 83 × 83 cm
- 1 × A1507AA
4-hole escutcheon 83 × 332 cm
- 1 × A1508AA
volume knob, hand shower
- 1 × A1509AA
volume knob, shower head
- 1 × A1512AA
temperature knob
- 1 × A4109AA
shower hose Idealflex 1.75 m
- 1 × A1519AA
stick hand shower
- 1 × B9443AA
rain shower Idealrain 300 mm
- 1 × A1524AA
wall connection 370 mm
- 1 × A1529AA
shower rail 90 cm with integrated wall elbow

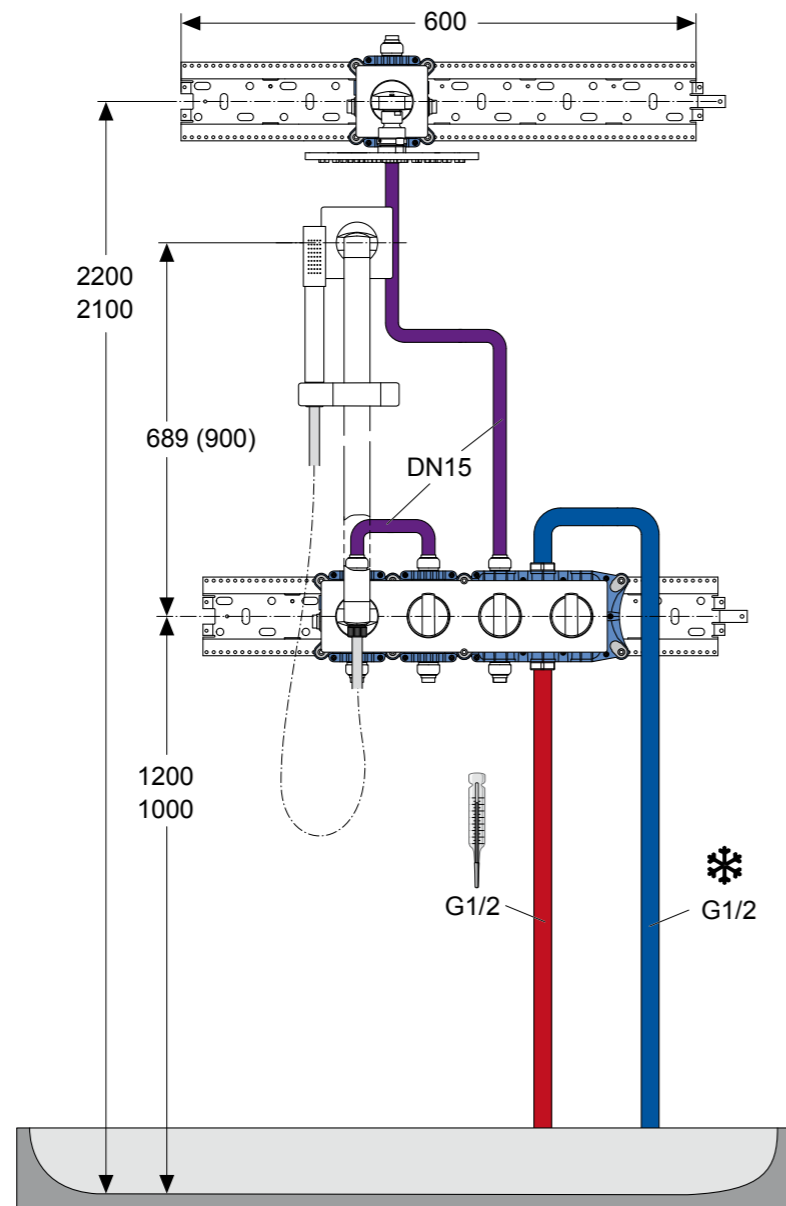

BATHS Compact



MODULE LIST

- 1 × A1500NU
built-in kit 1 THERMOSTAT
- 2 × A1501NU
built-in kit 1 UNIVERSAL
- 1 × A1507AA
4-hole escutcheon 83 × 332 cm
- 1 × A1511AA
volume knob, bath inlet
- 1 × A1512AA
temperature knob
- 1 × A1514AA
wall spout with integrated changeover (bath-shower)
- 1 × A3306AA
shower hose Idealflex 1,25 m
- 1 × A1519AA
stick hand shower
- 1 × A1520AA
wall bracket for hand shower

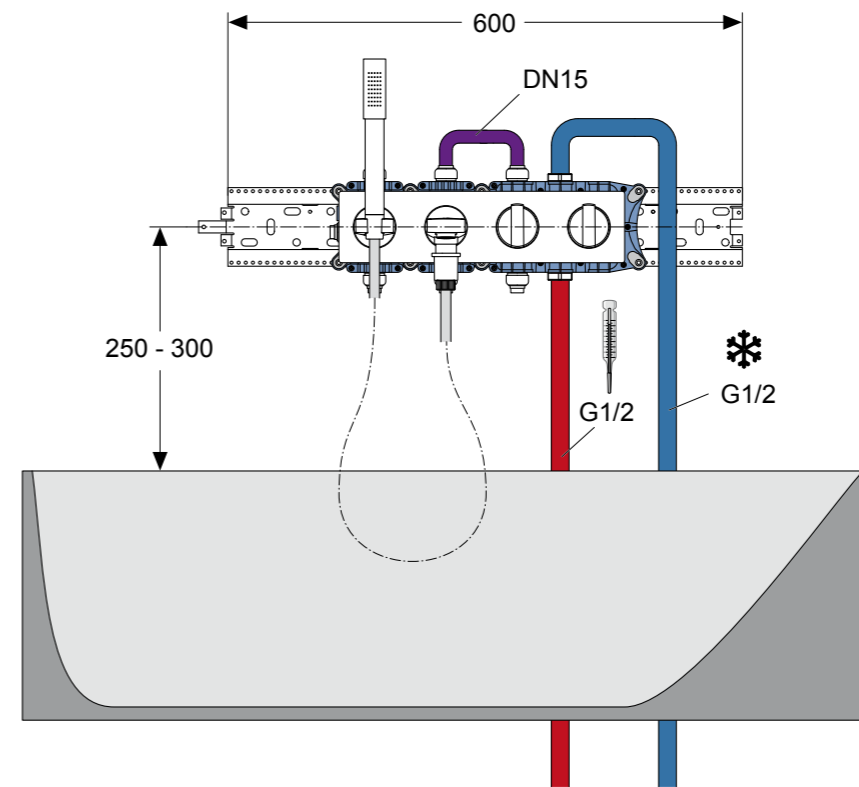

Flexible assembly

The installations shown are intended as examples only. The modules can also be assembled in different configurations – just as individual conditions demand.

INSTALLATION

SHOWERS Luxurious



MODULE LIST

- 1 × A1500NU
built-in kit 1 THERMOSTAT
- 3 × A1501NU
built-in kit 1 UNIVERSAL
- 1 × A1504AA
1-hole escutcheon 83 × 83 cm
- 1 × A1505AA
2-hole escutcheon 83 × 166 cm
- 1 × A1506AA
3-hole escutcheon 83 × 249 cm
- 1 × A1508AA
volume knob, hand shower
- 1 × A1509AA
volume knob, shower head
- 1 × A1512AA
temperature knob
- 1 × A4109AA
shower hose Idealflex 1.75 m
- 1 × A1519AA
stick hand shower
- 1 × A1521AA
wall elbow, flush-mounted
- 1 × B9443AA
rain shower Idealflex 300 mm
- 1 × A1530AA
shower system (without hand shower)

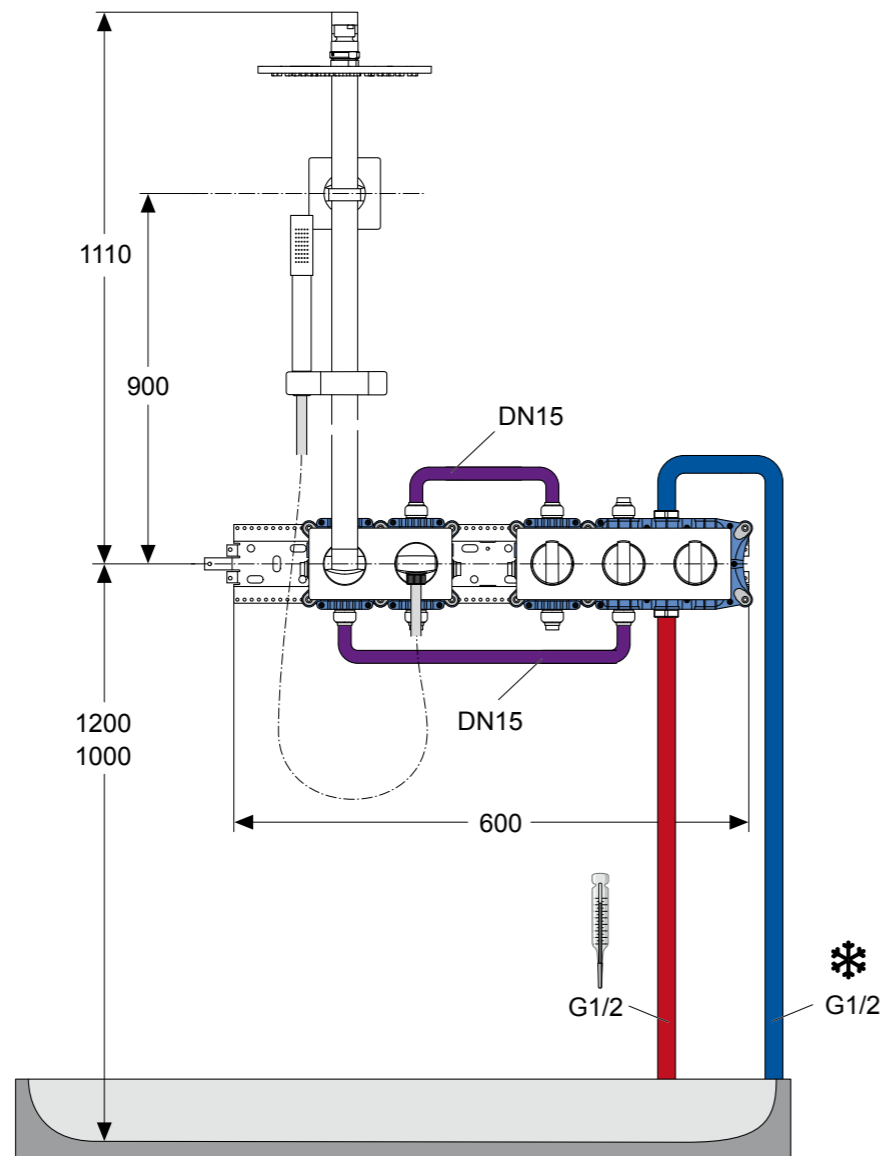

BATHS Luxurious



MODULE LIST

- 1 × A1500NU
built-in kit 1 THERMOSTAT
- 4 × A1501NU
built-in kit 1 UNIVERSAL
- 2 × A1506AA
3-hole escutcheon 83 × 249 cm
- 1 × A1508AA
volume knob, hand shower
- 1 × A1511AA
volume knob, bath inlet
- 1 × A1512AA
temperature knob
- 1 × A1513AA
wall spout
- 1 × A3306AA
shower hose Idealflex 1.25 m
- 1 × A1519AA
stick hand shower
- 1 × A1520AA
wall bracket for hand shower
- 1 × A1521AA
wall elbow, flush-mounted

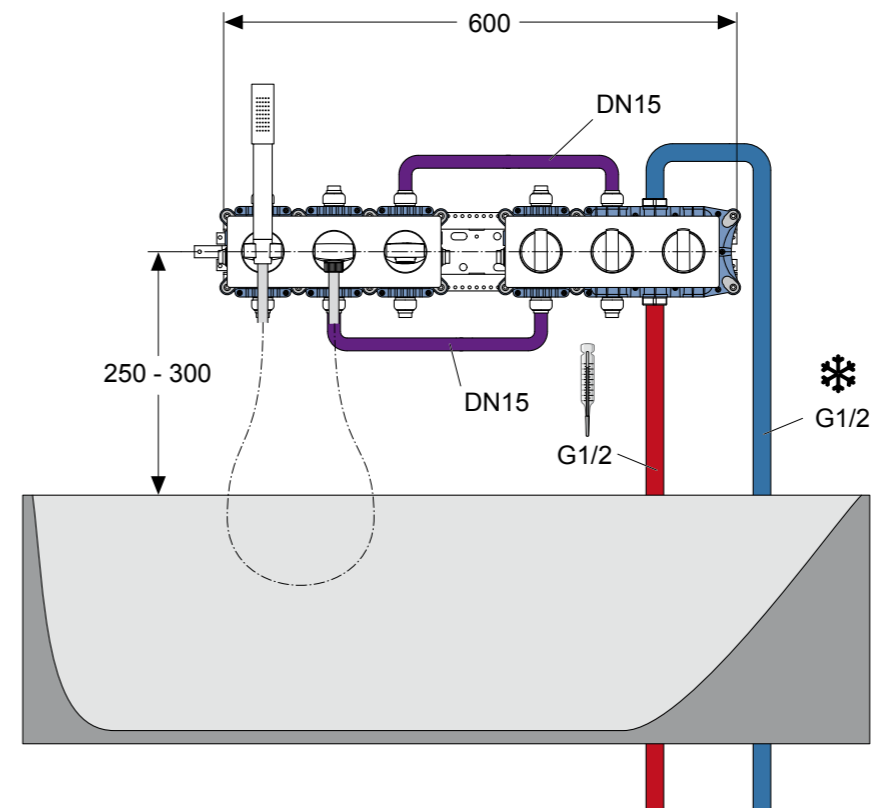

Flexible assembly

The installations shown are intended as examples only. The modules can also be assembled in different configurations – just as individual conditions demand.

INSTALLATION

SHOWERS Individual



MODULE LIST

- 1 × A1500NU
built-in kit 1 THERMOSTAT

- 1 × A1501NU
built-in kit 1 UNIVERSAL

- 1 × A1503NU
mounting rail 60 cm

- 2 × A1504AA
1-hole escutcheon 83 × 83 cm

- 1 × A1505AA
2-hole escutcheon 83 × 166 cm

- 1 × A1509AA
volume knob, shower head

- 1 × A1512AA
temperature knob

- 1 × A4109AA
shower hose Idealflex 1.75 m

- 1 × A1519AA
stick hand shower

- 1 × B9443AA
rain shower Idealrain 300 mm

- 1 × A1531AA
shower system with integrated
switch-over (without hand shower)

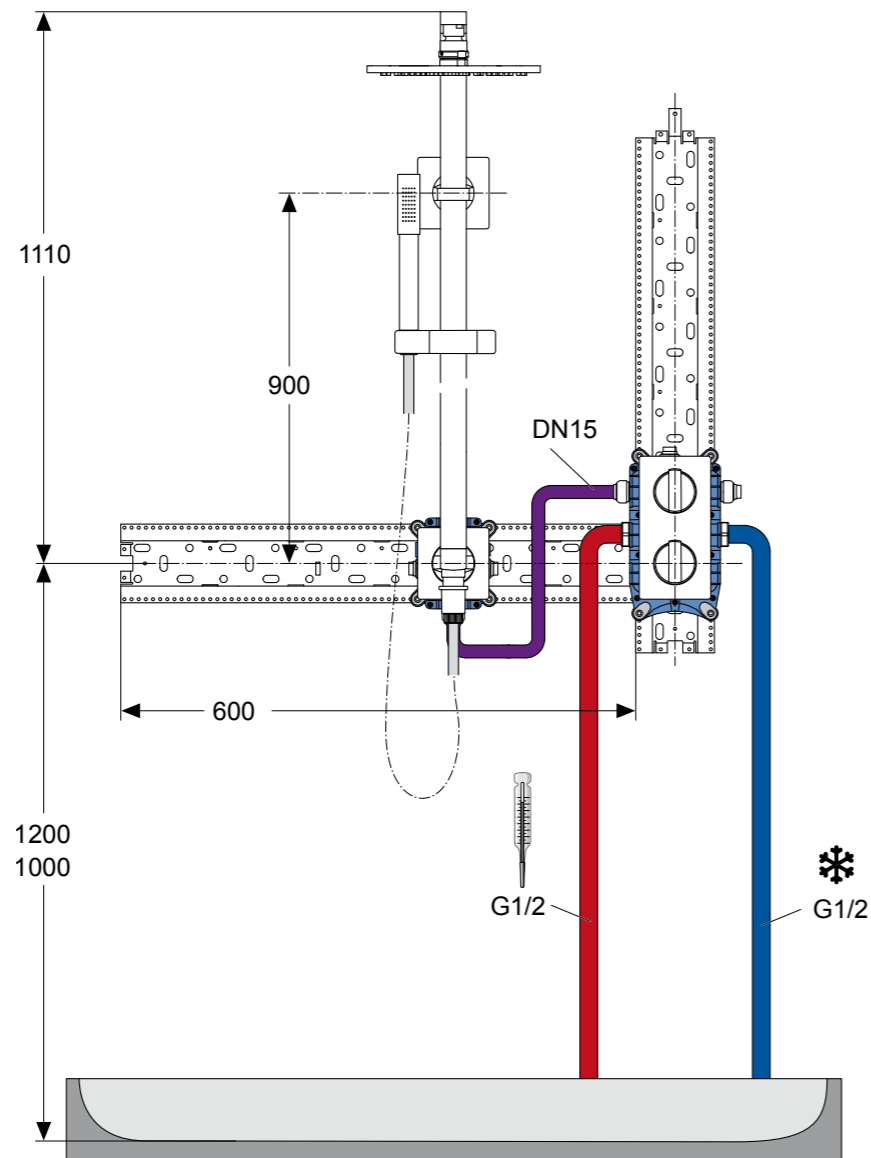

BATHS Individual



MODULE LIST

- 1 × A1500NU
built-in kit 1 THERMOSTAT

- 2 × A1501NU
built-in kit 1 UNIVERSAL

- 2 × A1505AA
2-hole escutcheon 83 × 166 cm

- 1 × A1511AA
volume knob, bath inlet

- 1 × A1512AA
temperature knob

- 1 × A1514AA
wall spout with integrated changeover
(bath-shower)

- 1 × A3306AA
shower hose Idealflex 1.25 m

- 1 × A1519AA
stick hand shower

- 1 × A1520AA
wall bracket for hand shower

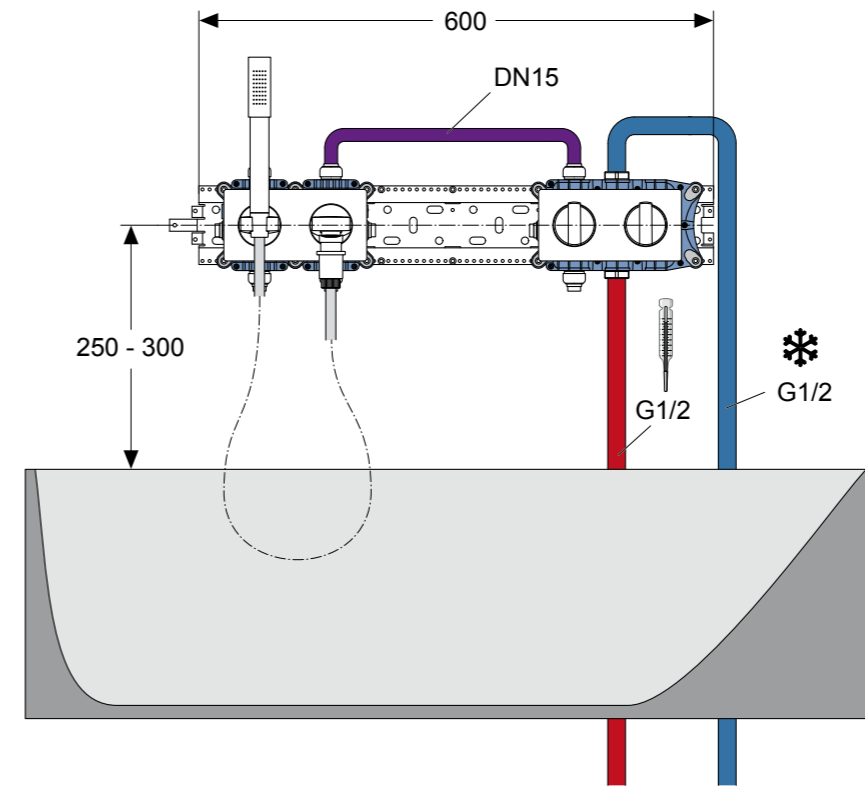

Flexible assembly

The installations shown are intended as examples only. The modules can also be assembled in different configurations – just as individual conditions demand.

INSTALLATION

WASHBASIN UNIT Comfortable



MODULE LIST

1 × A1500NU
built-in kit 1 THERMOSTAT

1 × A1501NU
built-in kit 1 UNIVERSAL

1 × A1504AA
1-hole escutcheon 83 × 83 mm

1 × A1505AA
2-hole escutcheon 83 × 166 mm

1 × A1511AA
volume knob, bath inlet

1 × A1512AA
temperature knob

1 × A1513AA
wall spout

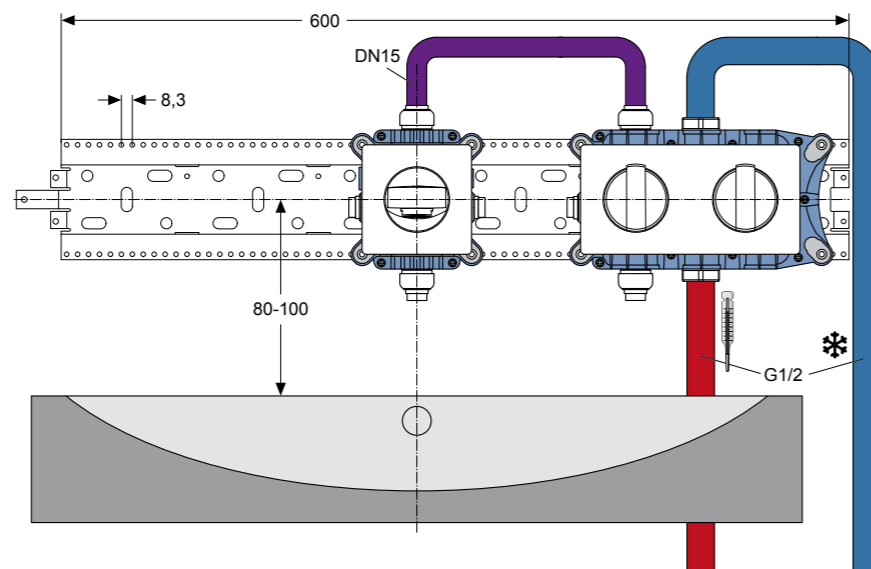

WASHBASIN UNIT Classic

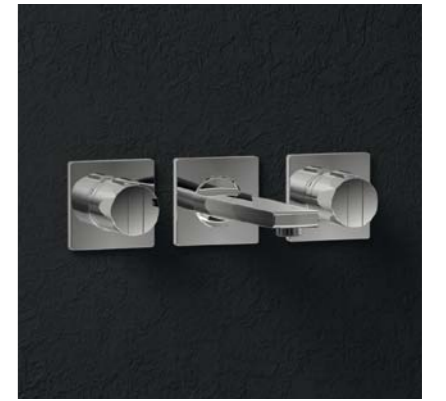

MODUL-LISTE

3 × A1501NU
built-in kit 1 UNIVERSAL

1 × A1503NU
mounting rail 60 cm

3 × A1504AA
1-hole escutcheon 83 × 83 mm

1 × A1522AA
volume knob, cold water (blue)

1 × A1523AA
volume knob, hot water (red)

1 × A1513AA
wall spout

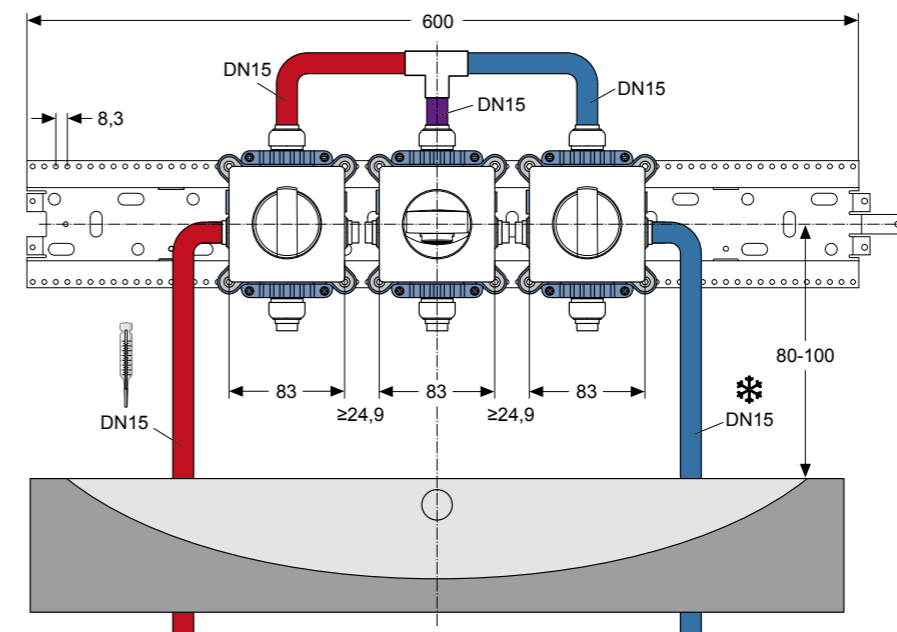

Flexible assembly

The installations shown are intended as examples only. The modules can also be assembled in different configurations – just as individual conditions demand.

MODULE OVERVIEW

34 modules – endless possibilities.

RAIN SHOWER IDEALRAIN



Ø 300 MM **B9443AA**

Ø 200 MM **B9442AA**

- connecting thread G1/2
- with ball joint
- pivots through 10°
- anti-limescale function
- AA chrome

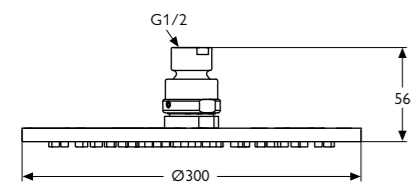

RAIN SHOWER IDEALRAIN PRO



300 × 300 MM **B9844AA**

400 × 400 MM **B9845AA**

- connecting thread G1/2
- with ball joint
- pivots through 10°
- anti-limescale function
- AA chrome

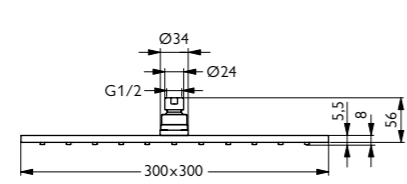

WALL CONNECTION 370MM



A1524AA

- wall connection for shower head G1/2
- including function kit 2
- without escutcheon
- AA chrome

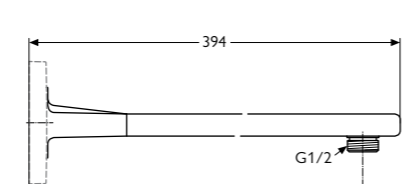

CEILING CONNECTOR 150 MM

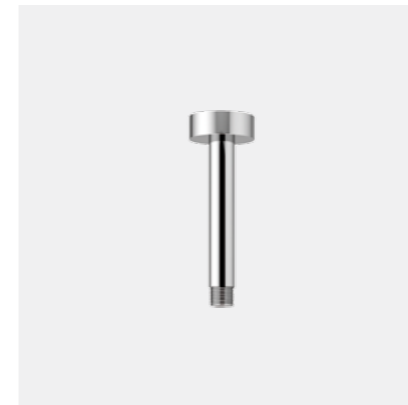

B9446AA

- ceiling connector for shower head G1/2
- including escutcheon
- AA chrome

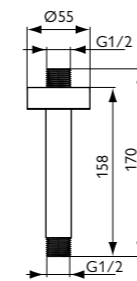

SHOWER RAIL



60 CM

A1526AA

90 CM

A1528AA

- including fixing kit 2
- with pivoting rotating slider, angular
- without escutcheons
- AA chrome

with integrated wall elbow G1/2:

60 CM

A1527AA

90 CM

A1529AA

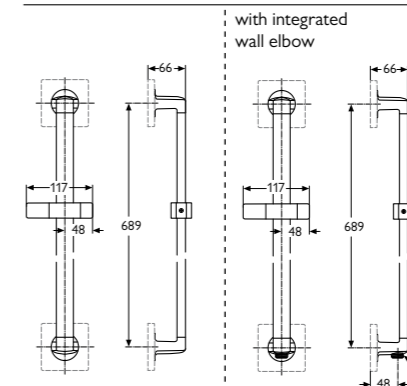

SHOWER SYSTEM

(without hand shower)



A1530AA

- including function kit 2
- water-conducting shower rail
- with integrated wall elbow
- with pivoting rotating slider, angular
- connection for shower head G1/2
- without escutcheons
- AA chrome

with integrated automatic switch-over:

A1531AA

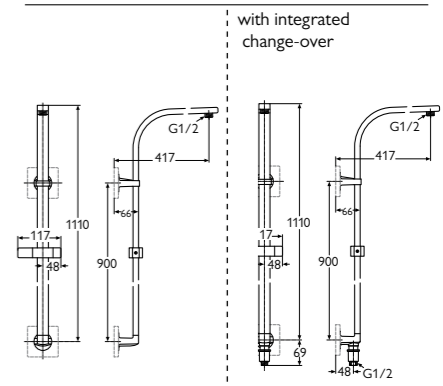

With our online configurator, you can assemble your personal design.
Just go to: www.archimodule.idealstandard.com

STICK HAND SHOWER



A1519AA

- single-function hand shower (normal water spray)
- AA chrome

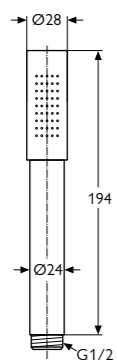

WALL BRACKET FOR HAND



A1520AA

- including fixing kit 2
- without escutcheon
- AA chrome

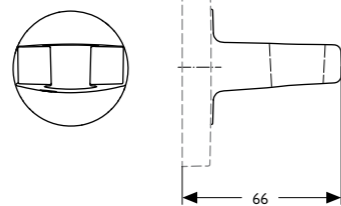

SHOWER WALL ELBOW



A1521AA

- including function kit 2
- including backflow preventer
- DVGW approved as intrinsically safe [German Technical and Scientific Association for Gas and Water]
- connecting thread G1/2
- without escutcheon
- AA chrome

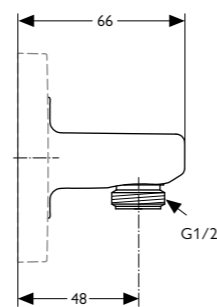

SHOWER HOSE "IDEALFLEX"



1,25 M

A3306AA

- made of plastic
- colour: silver
- connecting thread G1/2 × G1/2

1,6 M

A3330AA

1,75 M

A4109AA

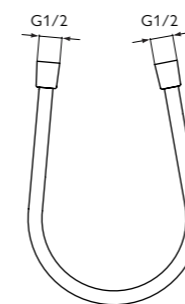

WALL SPOUT



A1513AA

- including function kit 2
- cast outlet spout, projection 190 mm
- with aerator
- without escutcheon
- AA chrome

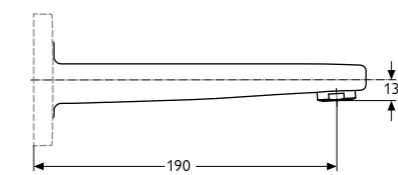

WALL SPOUT

(with integrated change-over)



A1514AA

- including function kit 2
- cast outlet spout, projection 190 mm
- with aerator
- integrated automatic changeover
- with backflow preventer at the shower outlet
- without escutcheon
- AA chrome

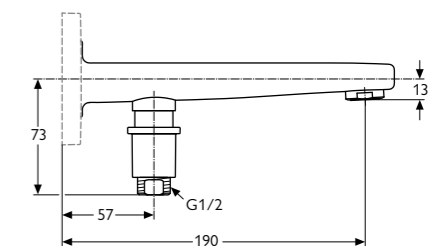

1-HOLE ESCUTCHEON 83 × 83 MM



A1504AA

- angular
- made of metal
- AA chrome

2-HOLE ESCUTCHEON 83 × 166 mm



A1505AA

- angular
- made of metal
- AA chrome

3-HOLE ESCUTCHEON 83 × 249 MM



A1506AA

- angular
- made of metal
- AA chrome

4-HOLE ESCUTCHEON 83 × 332 MM



A1507AA

- angular
- made of metal
- AA chrome

VOLUME KNOB



SYMBOL HAND SHOWER A1508AA

- including function kit 2
- symbol for water outlet on knob collar
- ECO saving button (except "cold" and "hot")
- AA chrome

TEMPERATURE KNOB



A1512AA

- including function kit 2
- red-blue markings on knob collar
- ECO saving button
- AA chrome

SYMBOL SHOWER HEAD A1509AA

SYMBOL SIDE NOZZLE A1510AA

SYMBOL BATH INLET A1511AA

SYMBOL COLD WATER (BLUE) A1522AA

SYMBOL HOT WATER (RED) A1523AA

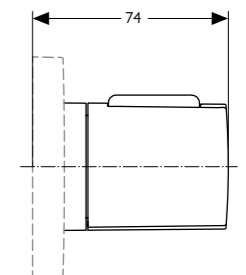
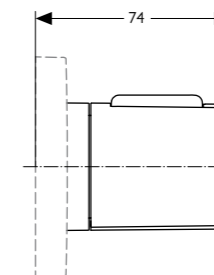
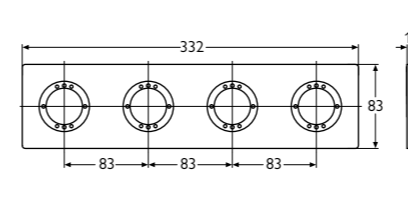
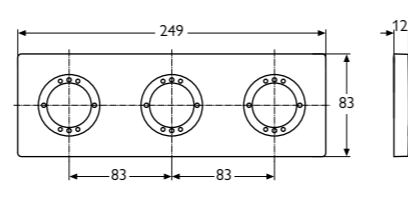
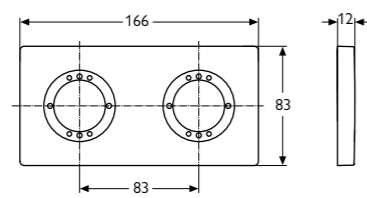
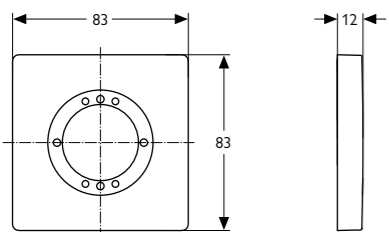

BUILT-IN KIT 1 THERMOSTAT



A1500NU

- flush-mounted installation kit 1 thermostat unit for wall mounting (kit 1)
- for pre-installation before tiling
- with plaster protective cover, purge block, sealing felt
- lateral stop cock
- with backflow preventer
- DVGW approved as intrinsically safe [German Technical and Scientific Association for Gas and Water]
- including mounting rail, 600 mm

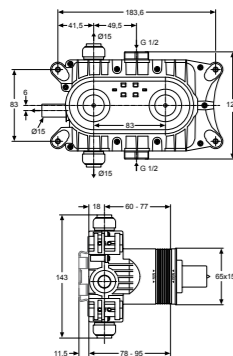

BUILT-IN KIT 1 UNIVERSAL



A1501NU

- universal kit 1 for wall installation
- for pre-installation before tiling
- with plaster protective cover, purge block, sealing felt

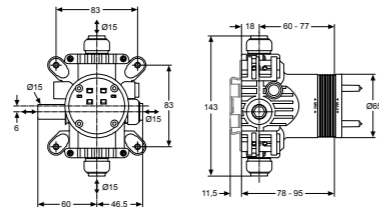

ACCESSORIES



MOUNTING RAIL 60 CM A1503NU

FIXING SET FOR MOUNTING RAIL A963713NU

- 2 items

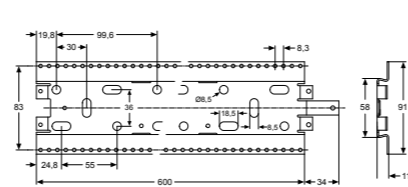

A963724AA 1-hole escutcheon 100 × 100 mm

- for covering too large hole cut-outs in the wall
- chrome

A963725AA 2-hole escutcheon 100 × 183 mm

- for covering too large hole cut-outs in the wall
- chrome

A963732AA 3-hole escutcheon 100 × 266 mm

- for covering too large hole cut-outs in the wall
- chrome

A963735AA 4-hole escutcheon 100 × 349 mm

- for covering too large hole cut-outs in the wall
- chrome

A963746AA spacer frame 1-hole escutcheon (83 × 83 mm)

- for flush-mounted kit installed too close to the surface
- gives an extra depth of 10 mm
- chrome

A963765AA spacer frame 2-hole escutcheon (83 × 166 mm)

- for flush-mounted kit installed too close to the surface
- gives an extra depth of 10 mm
- chrome

A963766AA spacer frame 3-hole escutcheon (83 × 249 mm)

- for flush-mounted kit installed too close to the surface
- gives an extra depth of 10 mm
- chrome

A963767AA spacer frame 4-hole escutcheon (83 × 332 mm)

- for flush-mounted kit installed too close to the surface
- gives an extra depth of 10 mm
- chrome

A963738NU extension for volume knob 15mm

- for extending volume knob by 15 mm
- where kit 1 is installed at too great a depth
- all items for the extension included

A963739NU extension for temperature knob 15 mm

- for extending temperature knob by 15 mm
- where kit 1 is installed at too great a depth
- all items for the extension included

A860825AA extension ring for shower rail (top fixing)

- chrome

A963723NU Flushing device

- for thermostat kit

A963713NU Fixing set for assembly system

- set consisting of 2 mounting feet
- for installation projecting from the wall, in pre-wall installation or prefabricated bathroom units or bathroom pods

OVERVIEW TABLE

Overview Archimodule

		SHOWERS Elegant	SHOWERS Compact	SHOWERS Luxurious	SHOWERS Individual	BATHS Elegant	BATHS Compact	BATHS Luxurious	BATHS Individual	WASHBASIN UNIT Comfortable	WASHBASIN UNIT Classic
A1500NU	built-in Kit 1 THERMOSTAT	1	1	1	1	1	1	1	1	1	
A1501NU	built-in Kit 1 UNIVERSAL	4	3	3	1	3	2	4	2	1	3
A1503NU	mounting rail 60 cm	1	1		1						1
A1504AA	1-hole escutcheon 83 × 83 mm	1	2	1	2					1	3
A1505AA	2-hole escutcheon 83 × 166 mm	1		1	1	1			2	1	
A1506AA	3-hole escutcheon 83 × 249 mm	1		1		1		2			
A1507AA	4-hole escutcheon 83 × 332 mm		1				1				
A1508AA	volume knob, hand shower	1	1	1		1		1			
A1509AA	volume knob, shower head	1	1	1	1						
A1511AA	volume knob, bath inlet					1	1	1	1	1	
A1522AA	volume knob, cold water (blue)										1
A1523AA	volume knob, hot water (red)										1
A1512AA	temperature knob	1	1	1	1	1	1	1	1	1	
A1513AA	wall spout							1		1	1
A1514AA	wall spout with integrated changeover (bath-shower)						1		1		
A3306AA	shower hose „Idealflex“ 1.25 m	1				1	1	1	1		
A4109AA	shower hose „Idealflex“ 1.75 m		1	1	1						
A1519AA	stick hand shower	1	1	1	1	1	1	1	1		
A1520AA	wall bracket for hand shower	1				1	1	1	1		
A1521AA	wall elbow, flush-mounted	1		1		1		1			
B9442AA	rain shower Idealrain 200 mm										
B9443AA	rain shower Idealrain 300 mm	1	1	1	1						
A1524AA	wall connection 370 mm	1	1								
A1529AA	shower rail 90 cm with integrated wall elbow		1								
A1530AA	shower system (without hand shower)			1							
A1531AA	shower system with integrated change-over (without hand shower)				1						
B9844AA	rainshower Idealrain PRO 300 × 300 mm										
B9845AA	rainshower Idealrain PRO 400 × 400 mm										
B9446AA	ceiling connector										

With our online configurator, you can assemble your personal design.
Just go to: www.archimodule.idealstandard.com

Ideal Standard GmbH

Euskirchener Straße 80

D-53121 Bonn

Postfach 18 09

D-53008 Bonn

Telephone: +49 (0) 228 521-0

Fax: +49 (0) 228 521-241

e-mail: idealstandard.de@idealstandard.com

Ideal Standard GmbH

Zweigniederlassung Österreich

Murbangasse 8

A-1108 Wien

Telephone: +43 (0) 1 2566 222-0

Fax: +43 (0) 1 2566 222-625

e-mail: idealstandard.at@idealstandard.com

www.idealstandard.com

For technical reasons in some printed illustrations the colours may vary.
We reserve the right to alter construction, measurement and design details.
We accept no liability for printing errors.

DEUTSCHE
STEINZEUG  **AGROB BUCHTAL**

Tiles: AGROB BUCHTAL, Inside-Out and Xeno ranges

